



P.O.Box-5598, DUBAI- United Arab Emirates
Tel +9714 8846146 Fax +9714 8846830
Email:mail@gulfex.com Web:www.gulfex.com

PROFILES

PROFILES

PROFILES

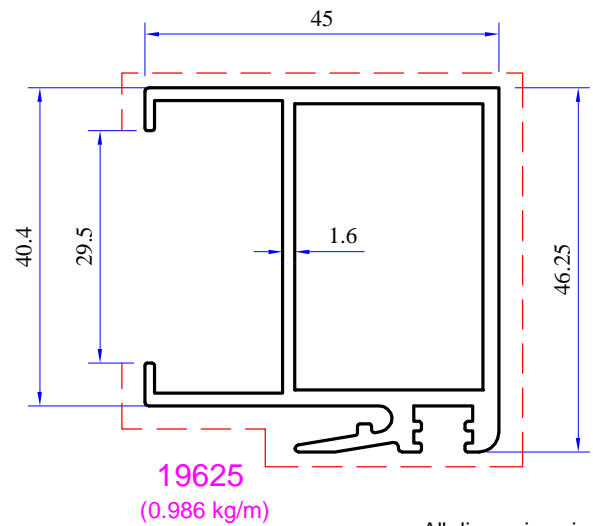
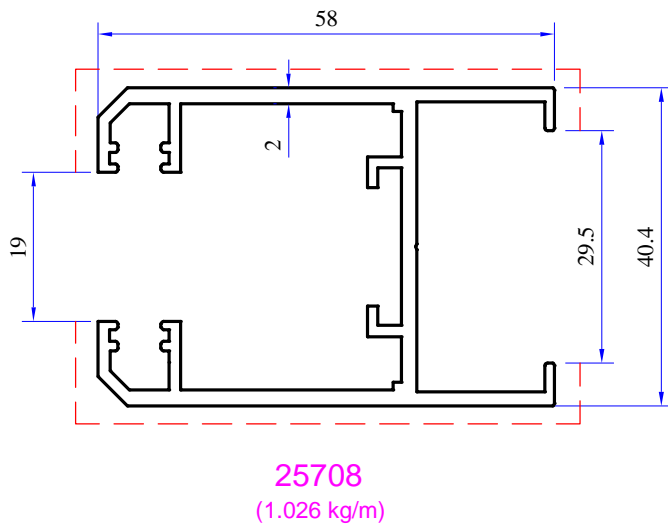
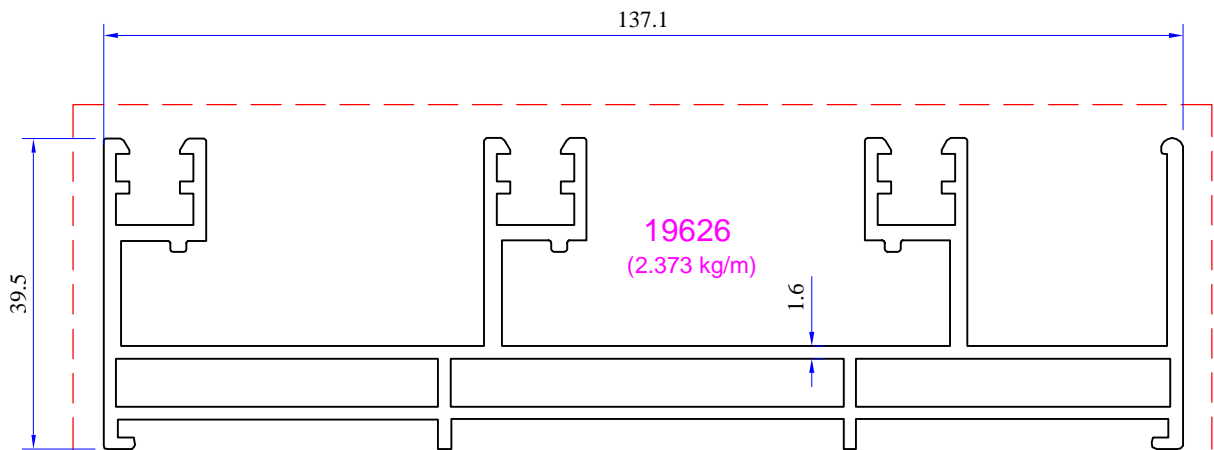
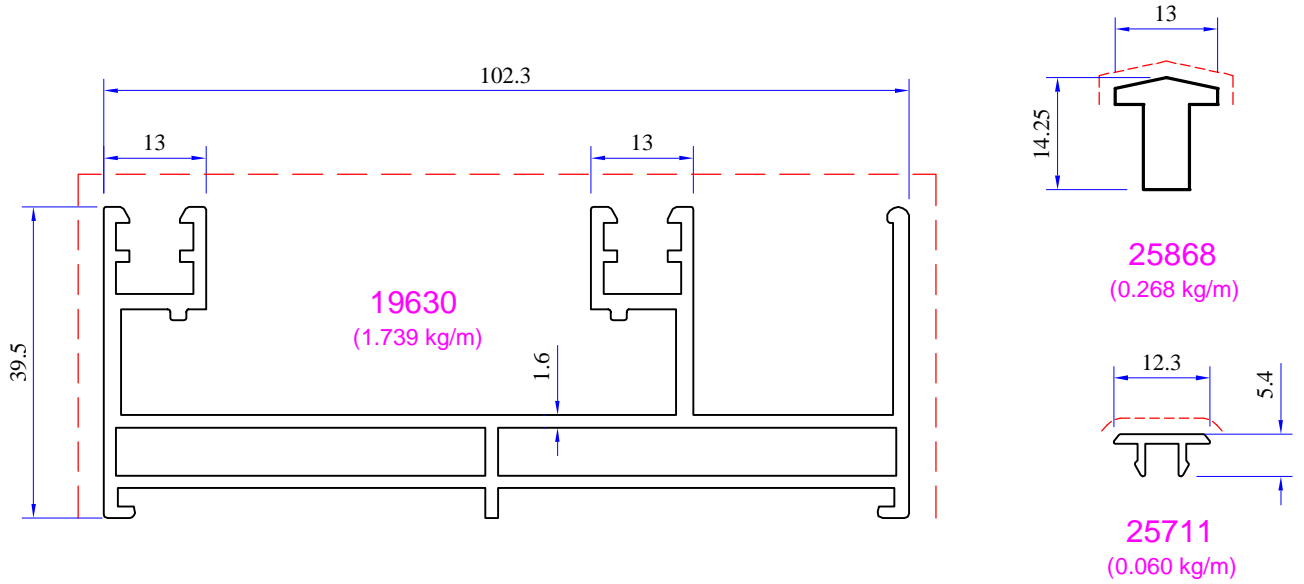

All dimensions in mm
----- Visible area

PROFILES

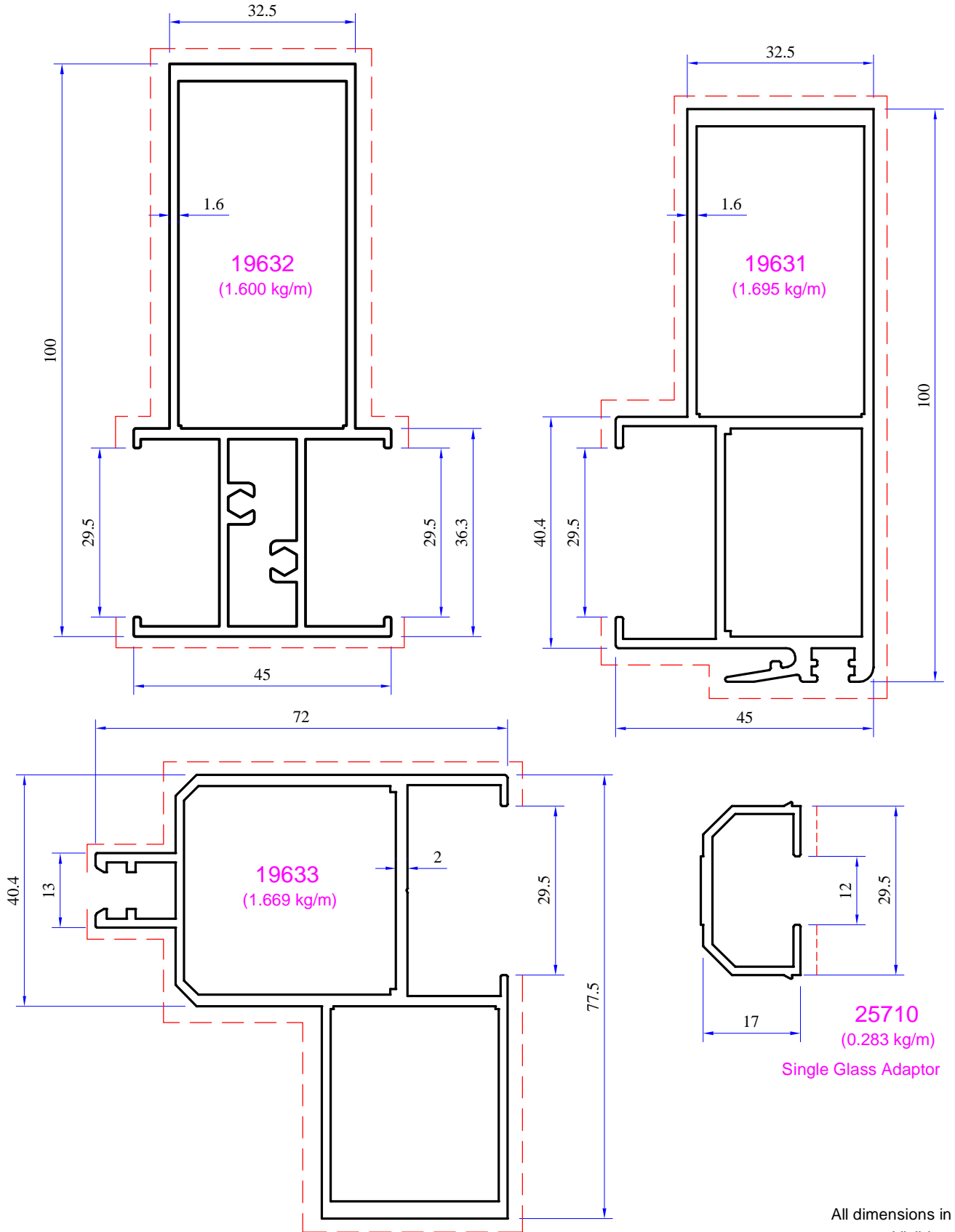



P.O.Box-5598, DUBAI- United Arab Emirates
Tel +9714 8846146 Fax +9714 8846830
Email:mail@gulfex.com Web:www.gulfex.com



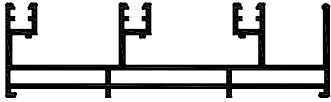
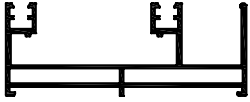
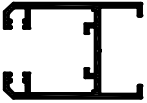
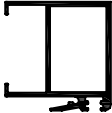
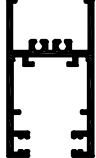
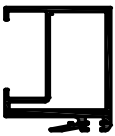
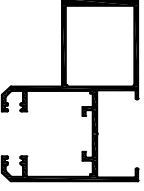

PROFILES

PROFILE LIST

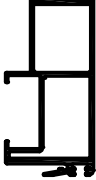
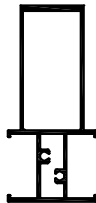
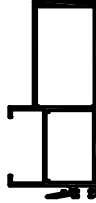
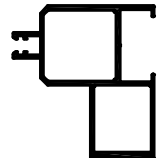

PROFILES

Profile Reference	Profile Section	Page	Weight KG/M	IX cm ⁴	IY cm ⁴	WX cm ³	WY cm ³
19626		XXXX	2.373	172.194	11.130	24.796	4.810
19630		XXXX	1.739	78.112	8.091	15.179	3.456
25708		XXXX	1.026	10.461	10.720	5.178	3.632
19625		XXXX	0.986	10.644	6.683	4.434	2.391
25709		XXXX	1.149	15.183	9.452	4.448	5.208
19628		XXXX	1.257	16.163	9.484	5.429	3.656
19629		XXXX	1.585	41.625	16.554	10.129	4.991

PROFILES

Profile Reference	Profile Section	Page	Weight KG/M	IX cm ⁴	IY cm ⁴	WX cm ³	WY cm ³
19627		XXXX	1.820	63.770	13.103	12.759	4.887
19632		XXXX	1.600	70.311	9.100	13.337	4.044
19631		XXXX	1.695	72.387	11.461	13.632	4.057
19633		XXXX	1.669	41.829	25.834	9.982	5.966
25710		XXXX	0.283	---	---	---	---
25868		XXXX	0.268	---	---	---	---
25711		XXXX	0.060	---	---	---	---

ACCESSORIES

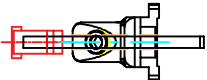
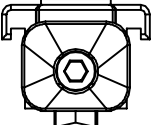
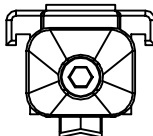
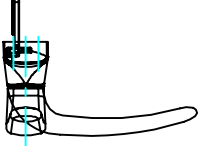
Gasket / Accessories Reference	Section	Description	Unit
----		EPDM Rubber U- Type to be Used with Sash to hold 24 mm Glass	Linear Meter
----		EPDM Rubber to be Used with Sash to hold 6.0 mm Glass	Linear Meter
----		Brush 5.5mm to be used in the Sash	Linear Meter
NIB HOLDER -03340000 STRAIGHT NIB -03345000 COUNTER PLATE -03328000 CONNECTION ROD -03524590N		Handle application of NIB & NIB Holder	Piece
03115000		Single Pulley	Piece
03116000		Double Pulley	Piece
CREMONE 01150FFF FORK 02403000 PAWL 04027000K		Cremone Handle	Piece

ASSEMBLY DRAWING

2-TRACK / 2-SASH

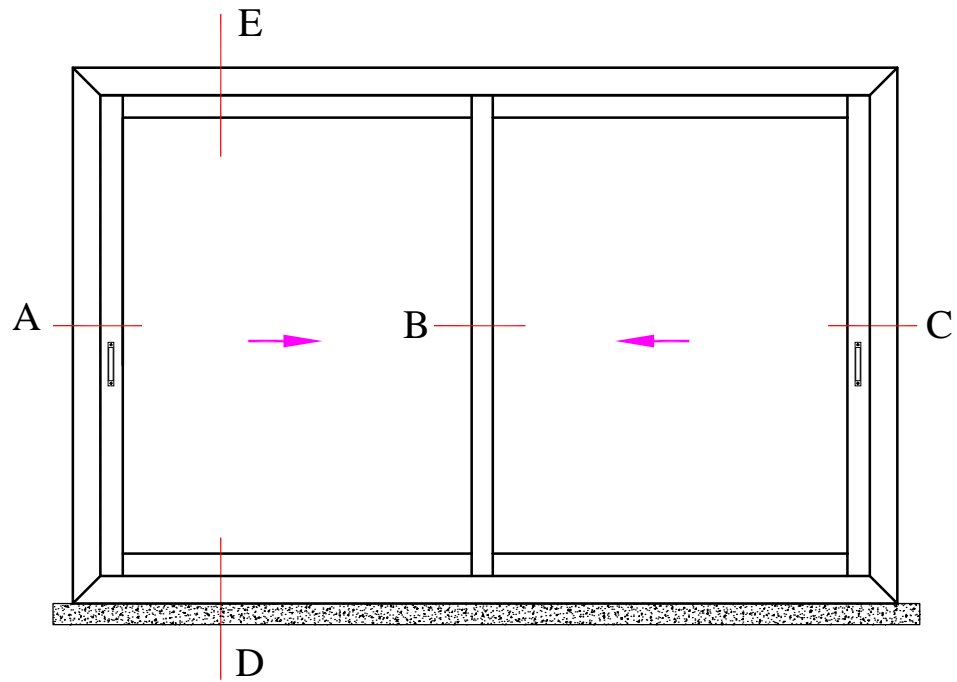

All dimension in cross sections are shown in mm
Profiles are not necessarily shown to scale

ASSEMBLY DRAWING

DETAIL - A

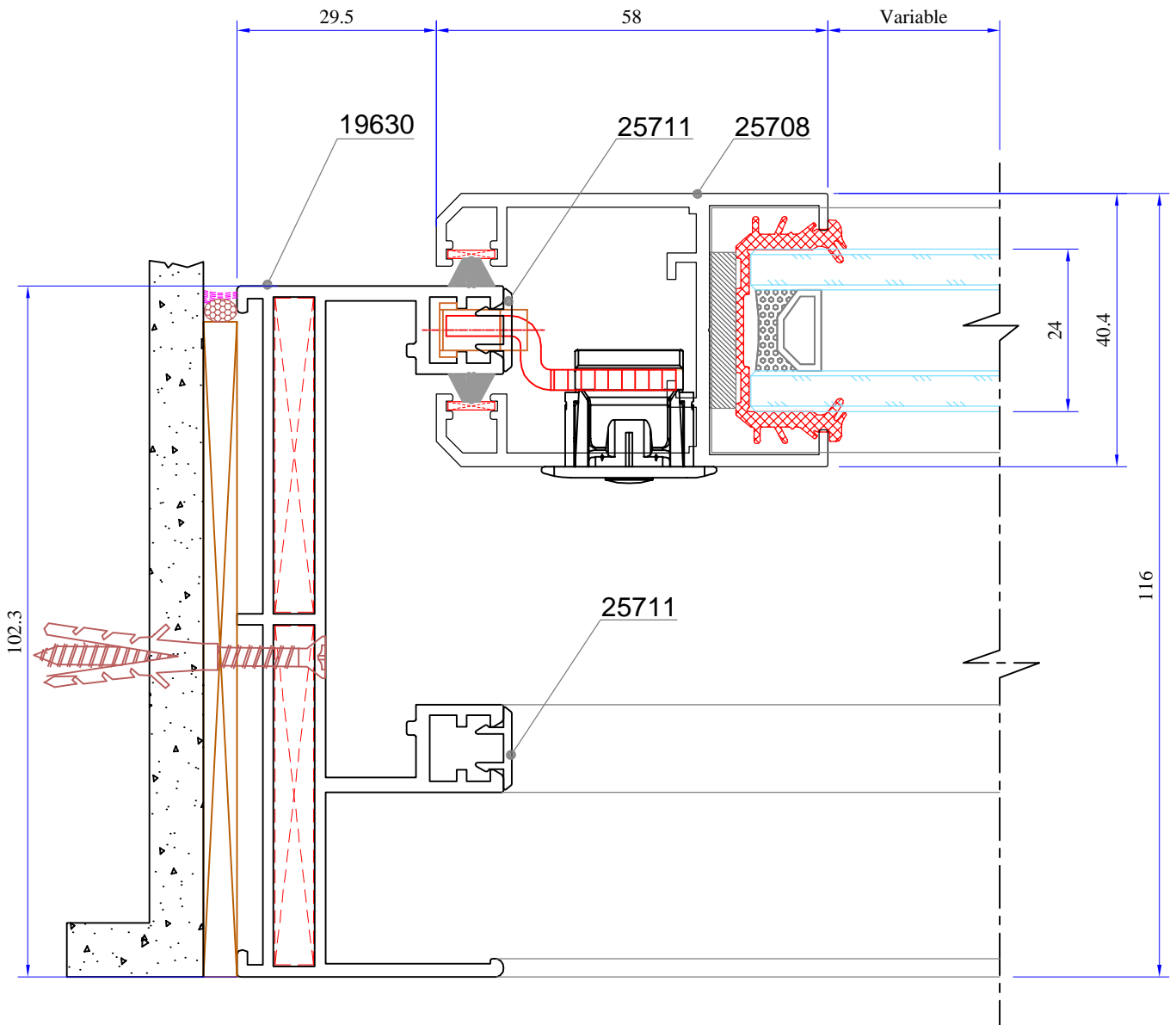

ASSEMBLY DRAWING

DETAIL - B

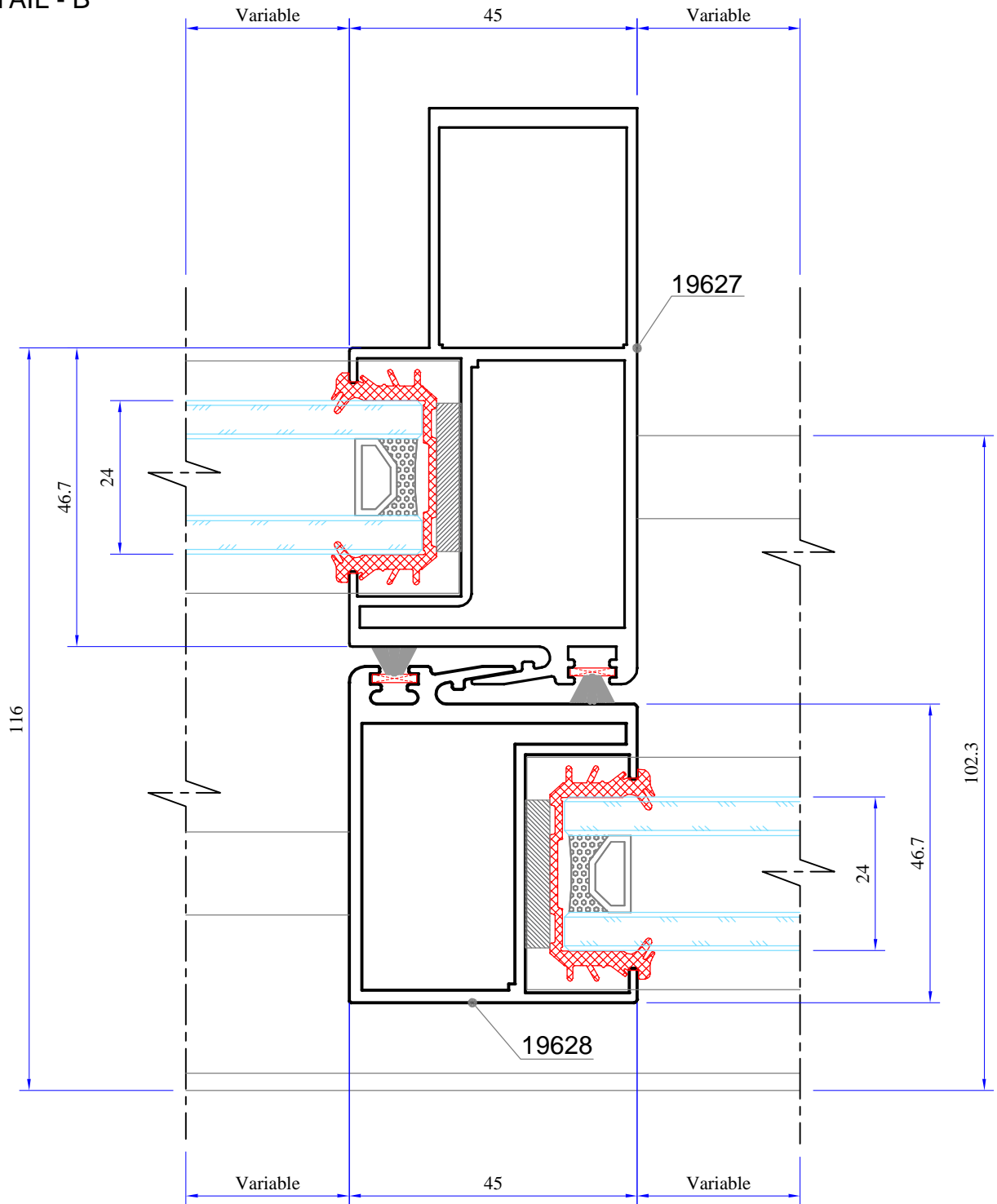

ASSEMBLY DRAWING

DETAIL - C

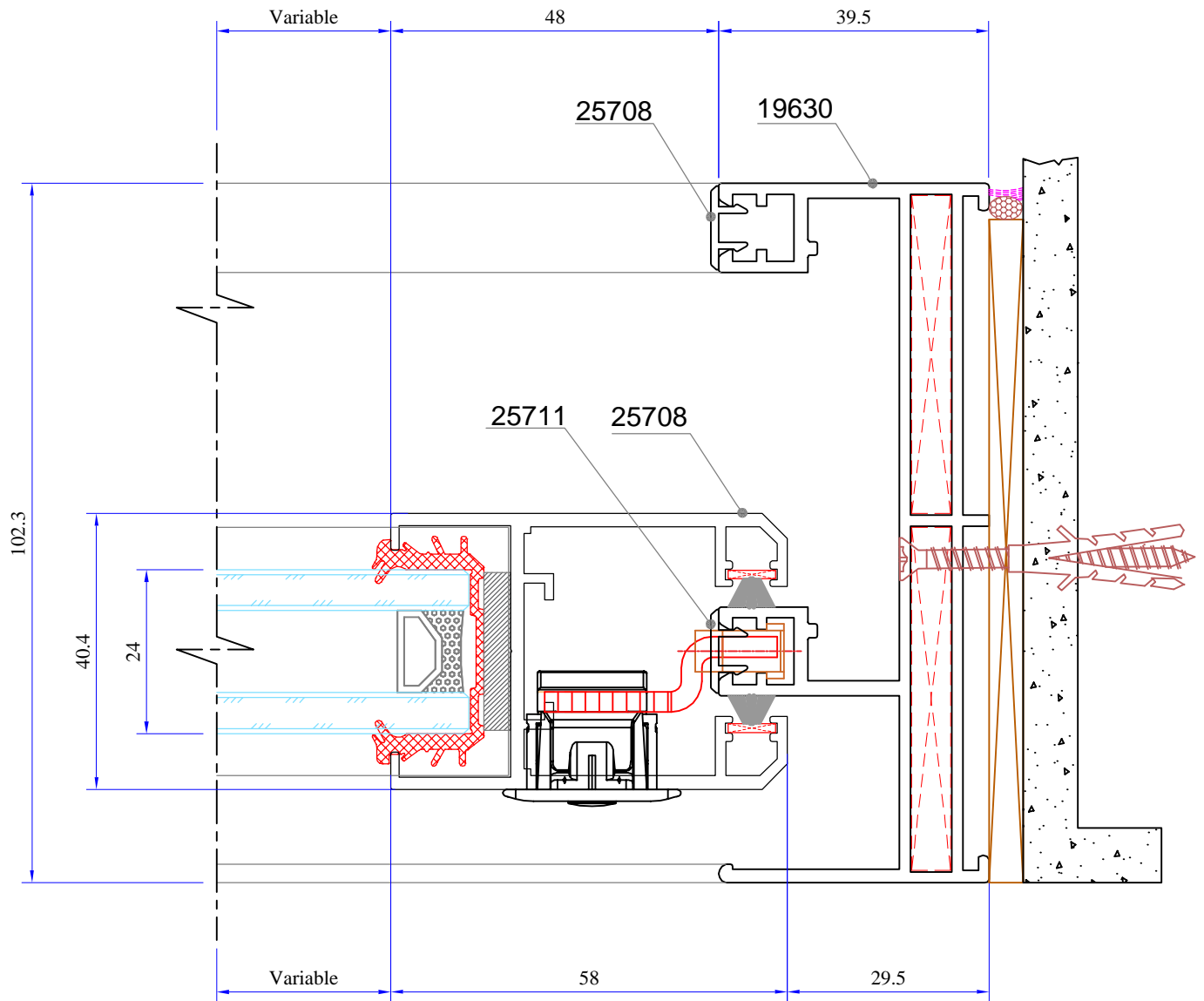

ASSEMBLY DRAWING

DETAIL - D

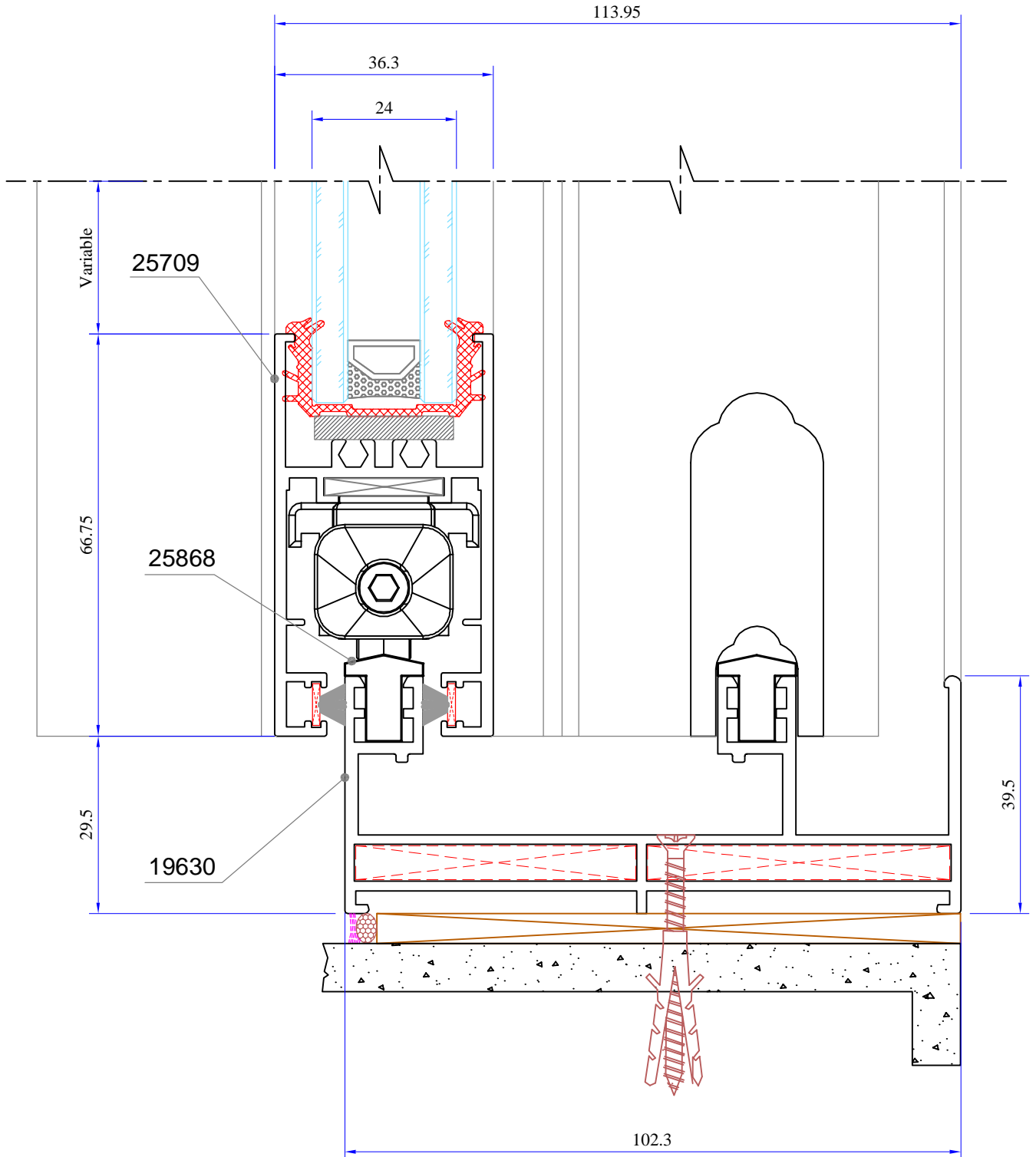

ASSEMBLY DRAWING

DETAIL - E

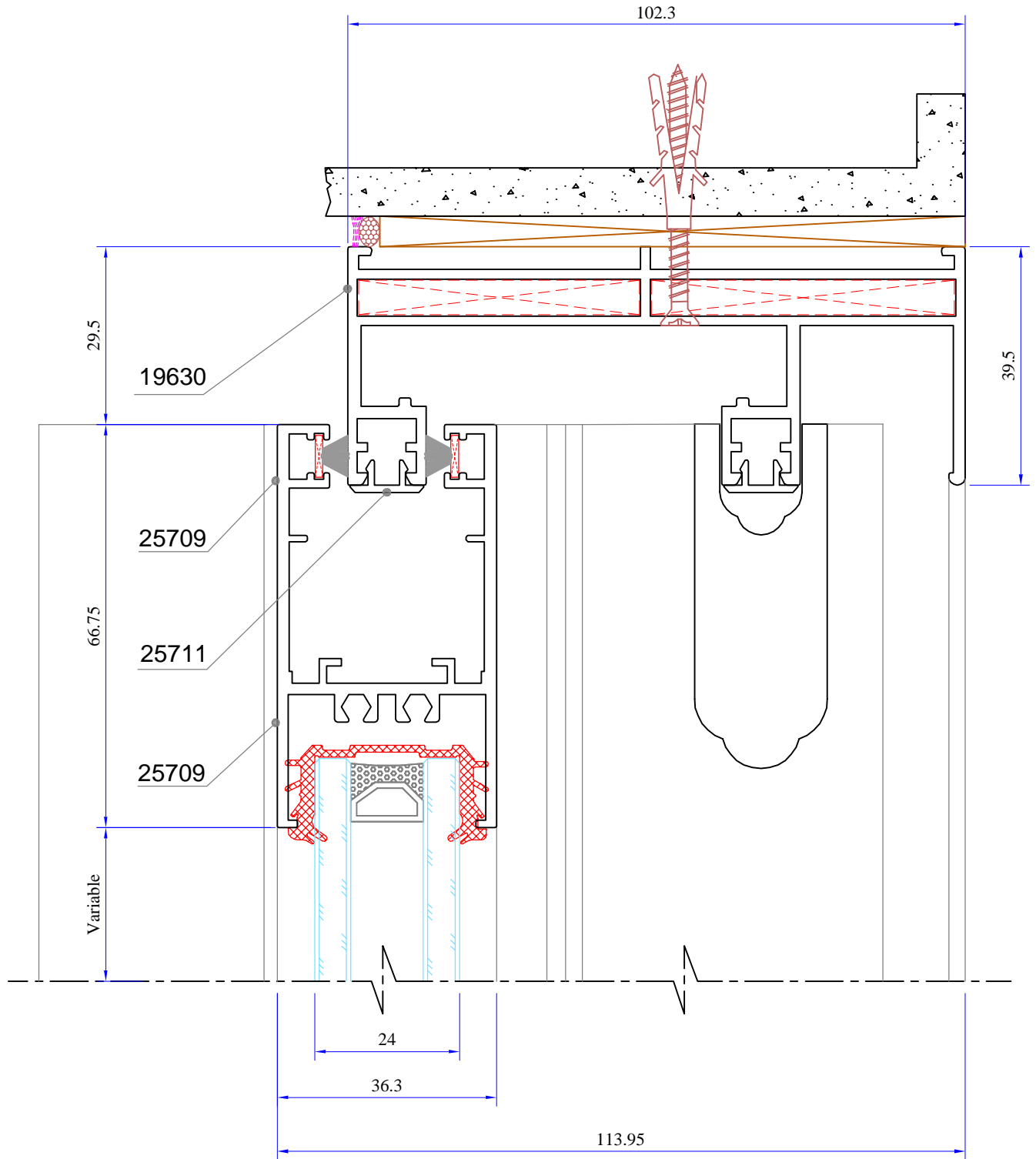

ASSEMBLY DRAWING

Double Glass unit with
Thickness 24 mm

B | 2 - SASH WINDOW

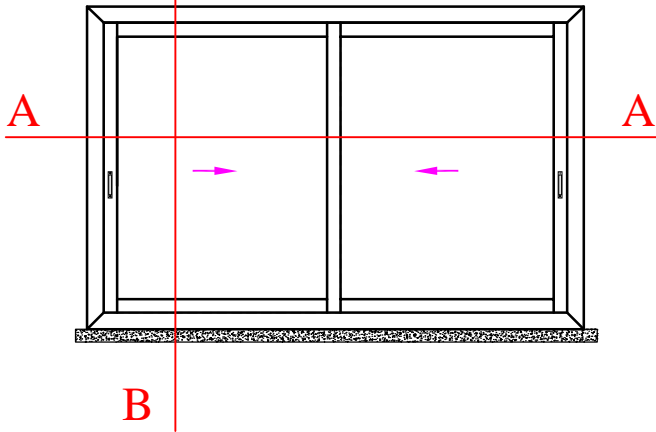

DETAIL : B-B

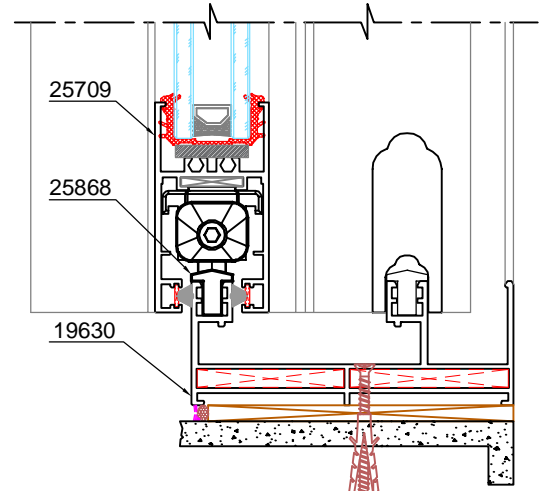
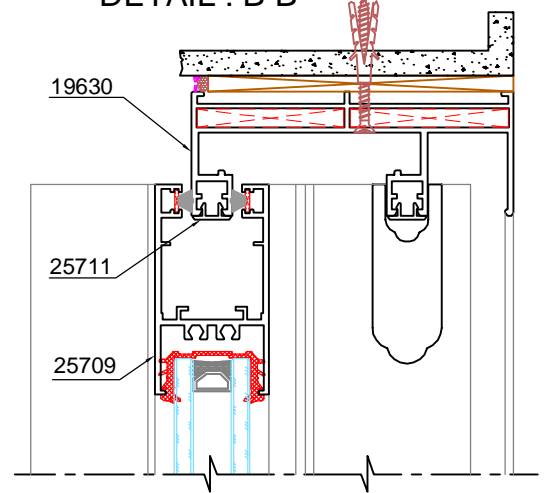

PROFILES (Double Glazed)

Description	Shape	Section No.
Frame		19630
Bottom/Top Sash		25709
Side Sash		25708
Interlock		19628
Interlock reinforcement		19627
Cap-Side & top		25711
Bottom Secion		25868

DETAIL : A-A

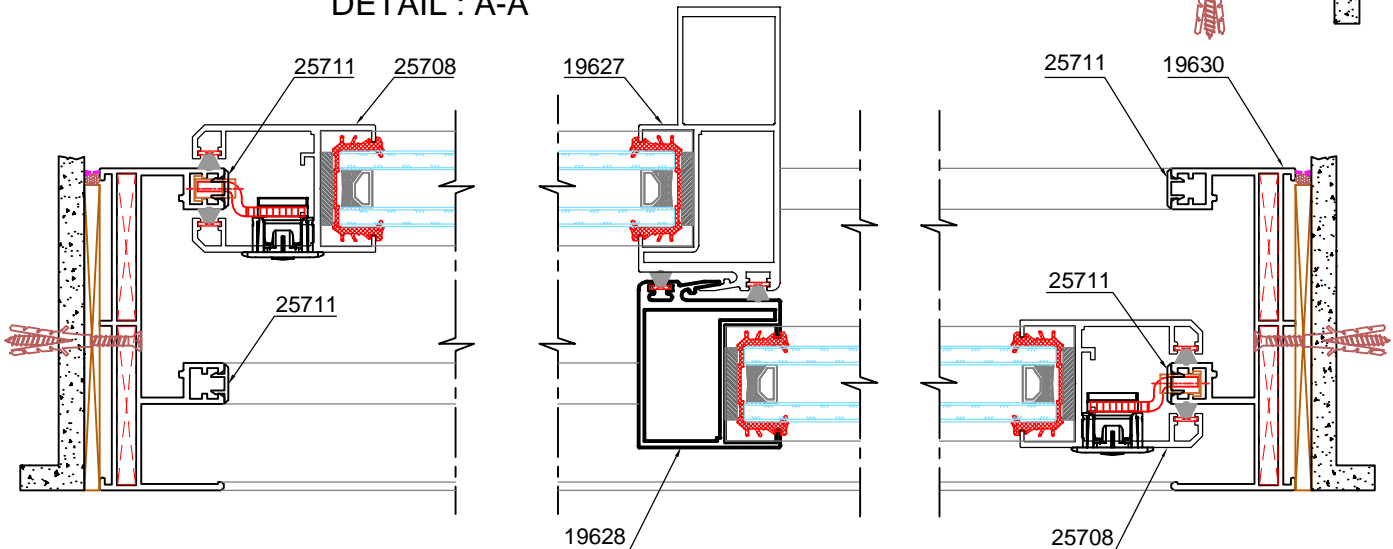

ASSEMBLY DRAWING

2-TRACK / 4-SASH

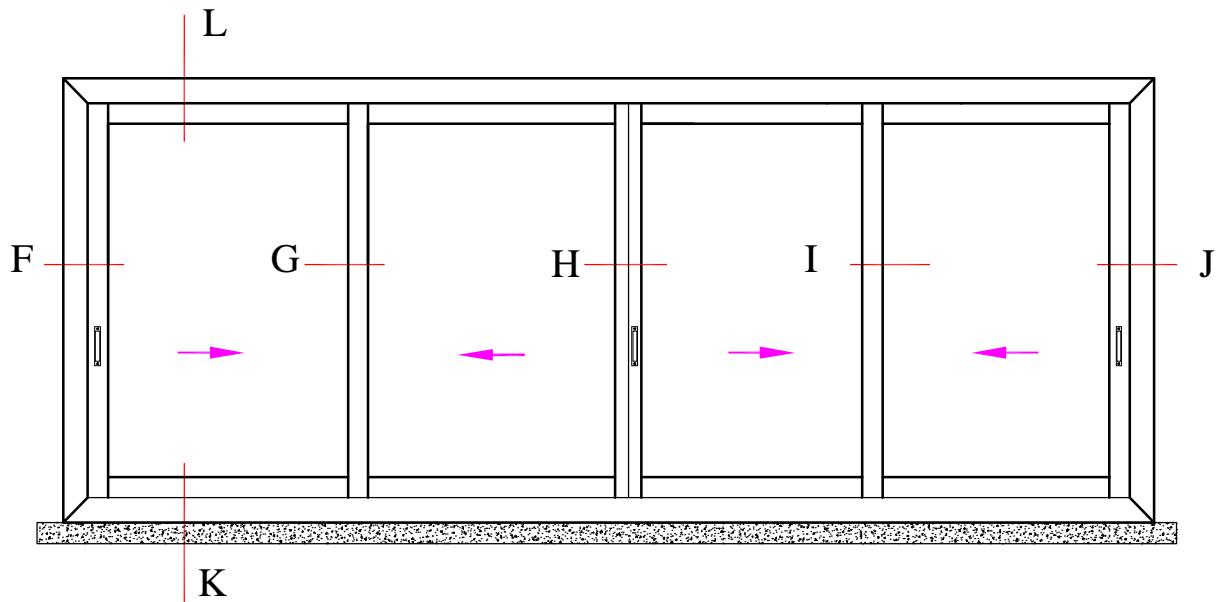

All dimension in cross sections are shown in mm
Profiles are not necessarily shown to scale

ASSEMBLY DRAWING

DETAIL - F

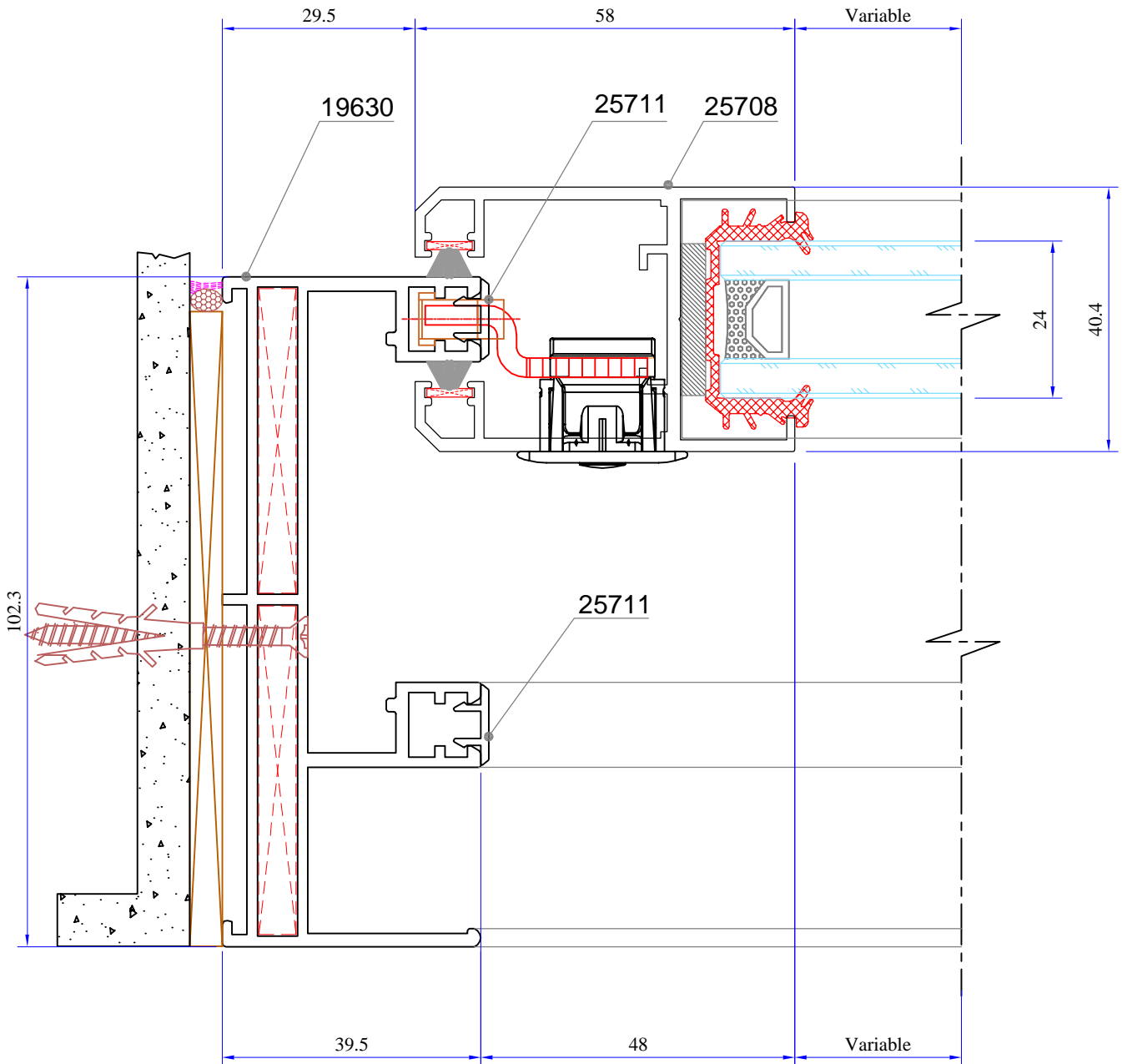

ASSEMBLY DRAWING

DETAIL - G

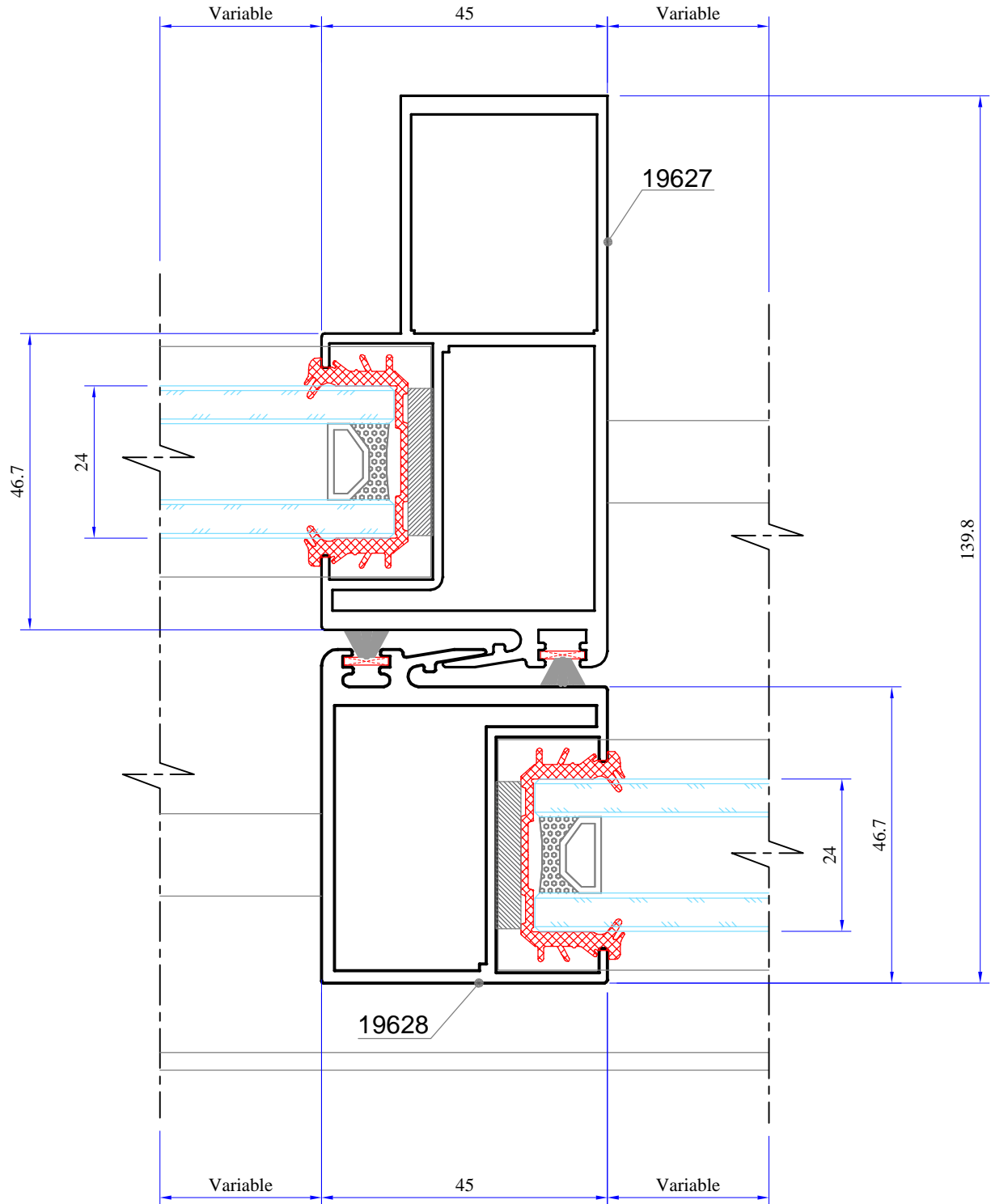

ASSEMBLY DRAWING

DETAIL - H

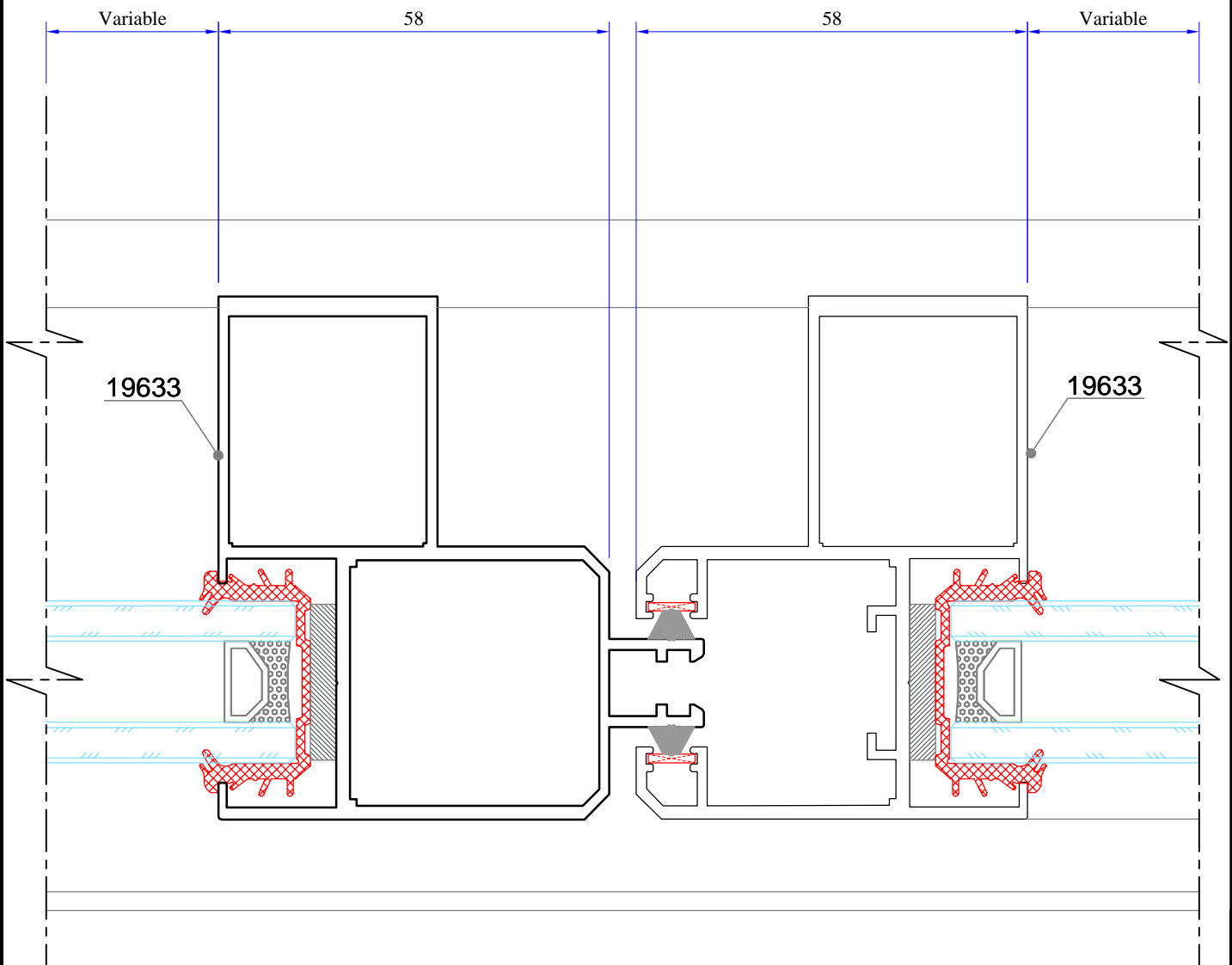

ASSEMBLY DRAWING

DETAIL - I

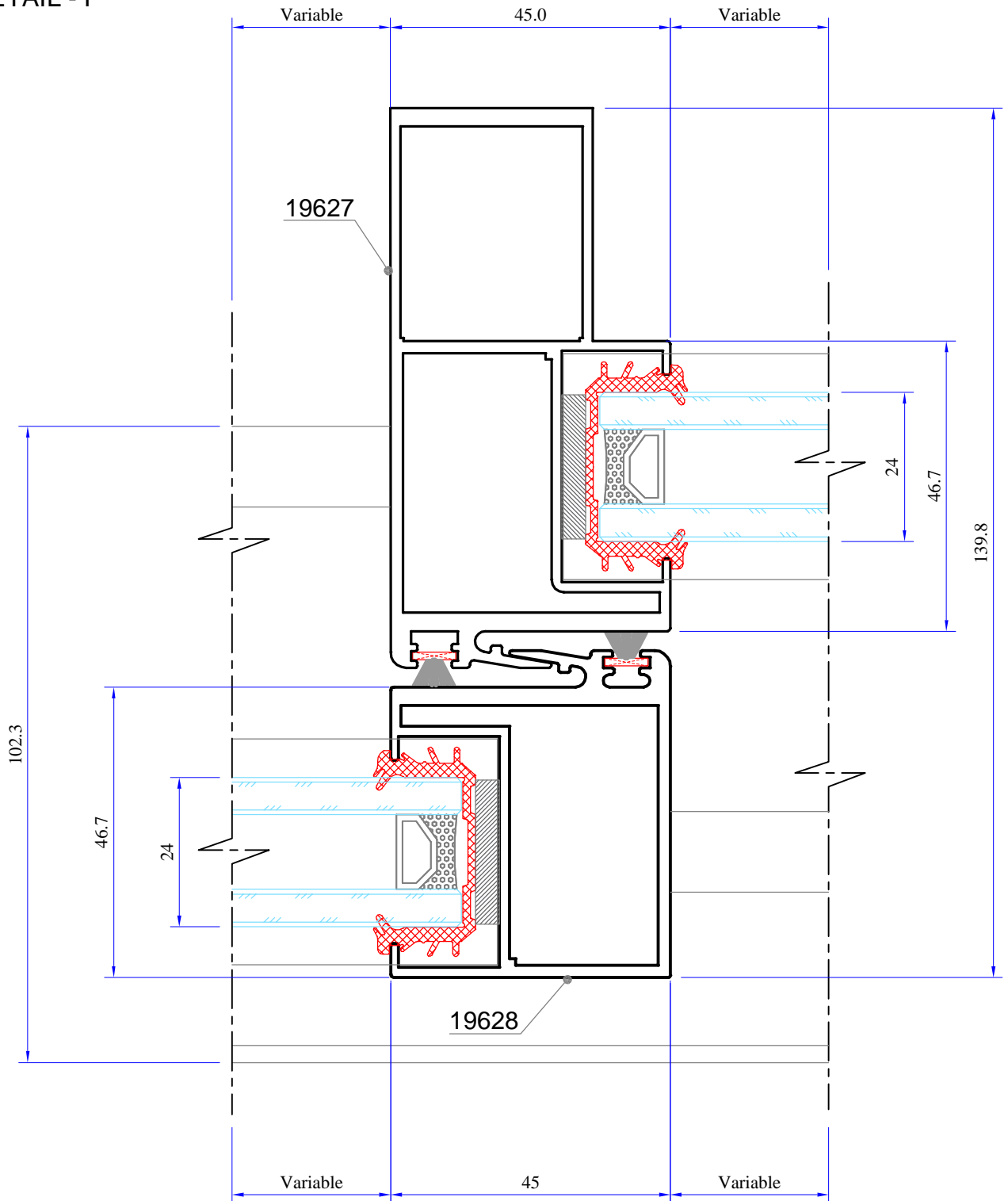

ASSEMBLY DRAWING

DETAIL - J

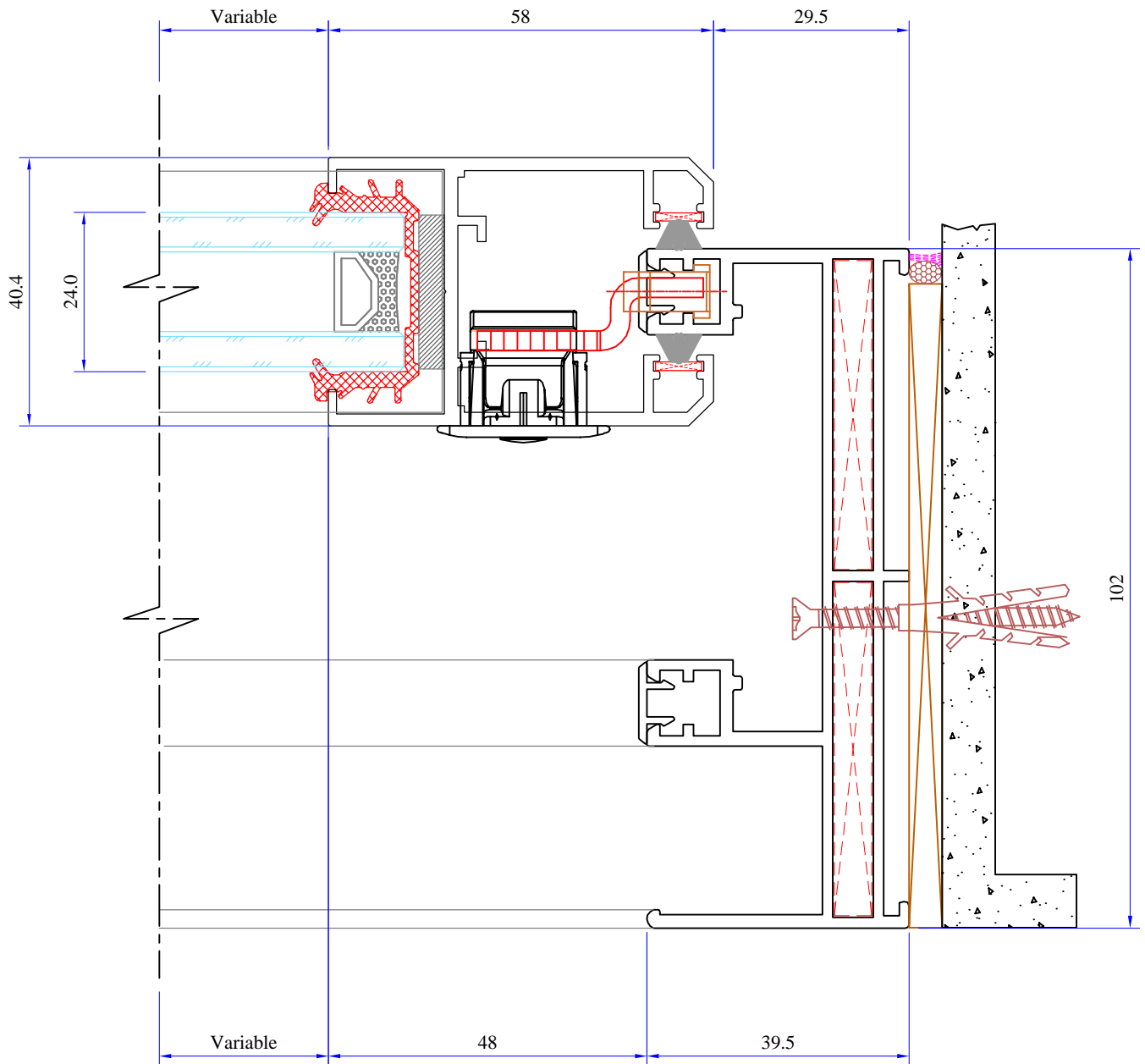

ASSEMBLY DRAWING

DETAIL - K

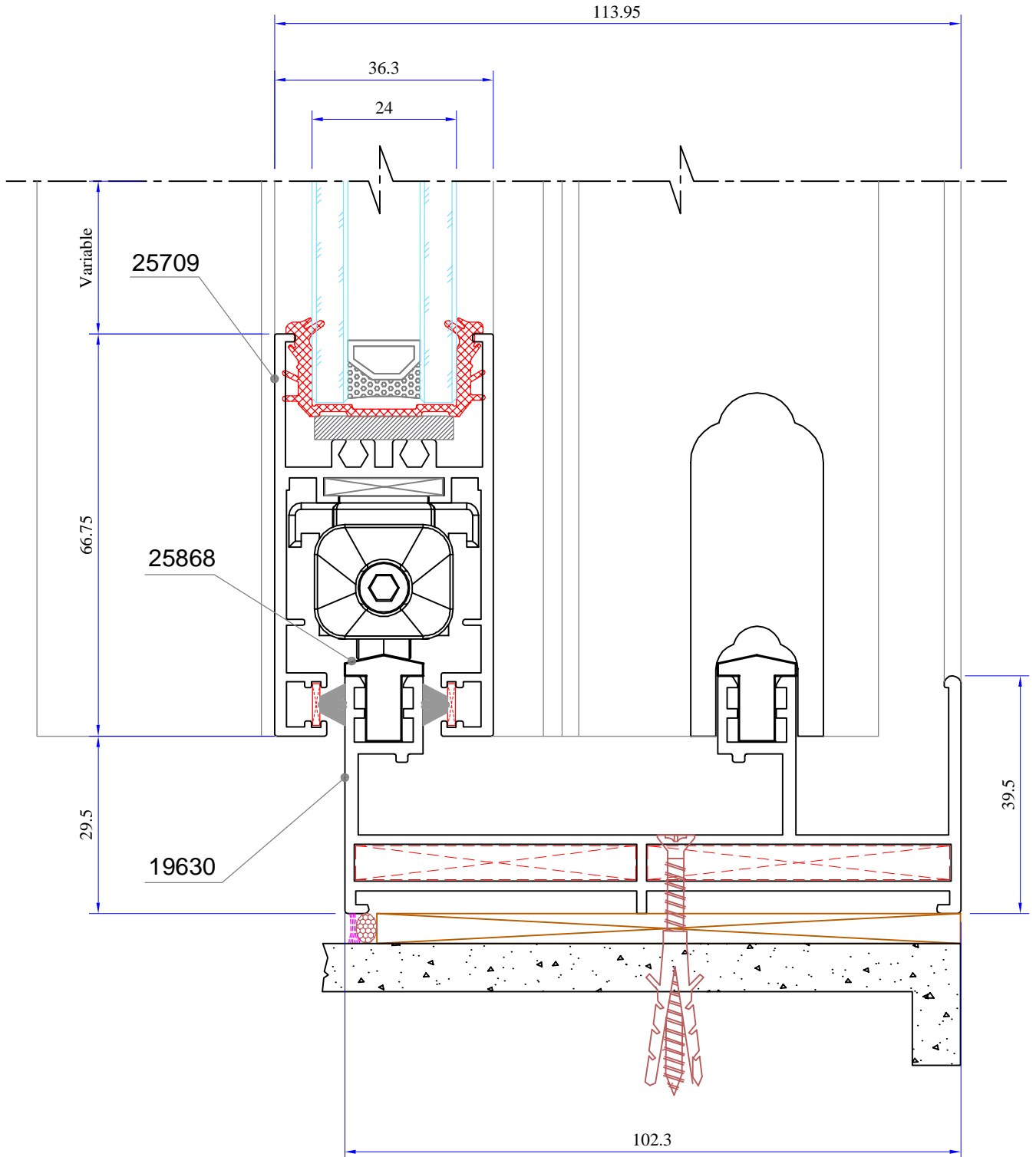

ASSEMBLY DRAWING

DETAIL - L

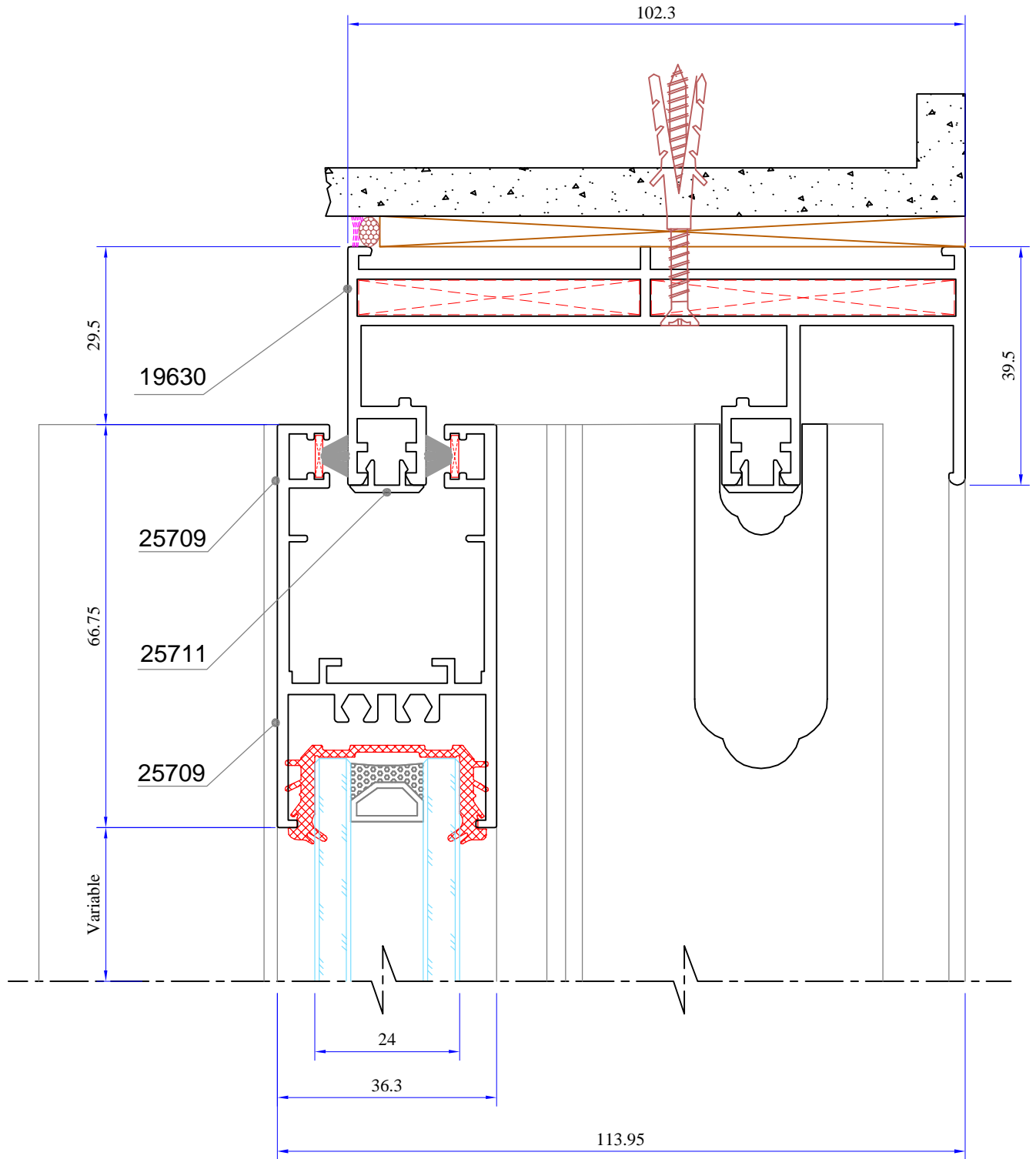

ASSEMBLY DRAWING

4 - SASH WINDOW

Double Glass unit with
Thickness 24 mm

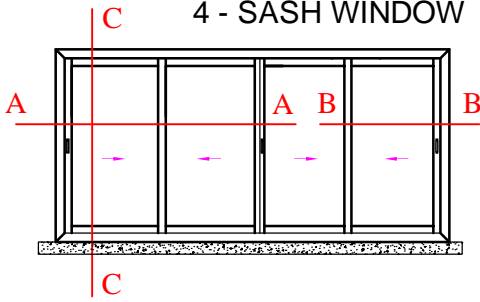

PROFILES (Double Glazed)		
Description	Shape	Section No.
Frame		19630
Bottom/Top Sash		25709
Side Sash		25708
Interlock		19628
Interlock reinforcement		19627
Meeting section		19633
Cap Side & top		25711
Bottom Secion		25868

DETAIL : C-C

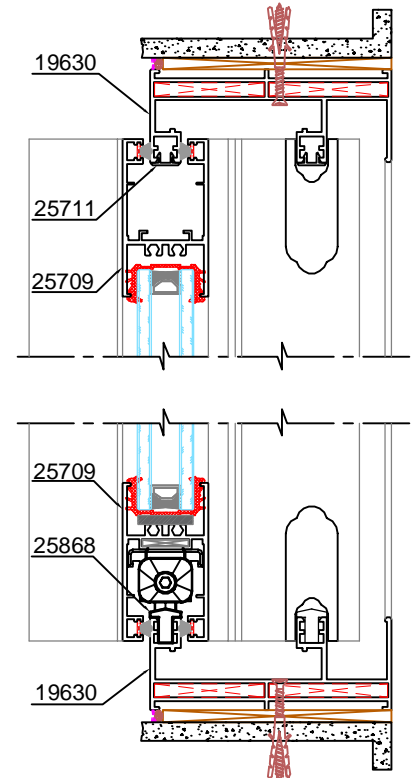

DETAIL : A-A

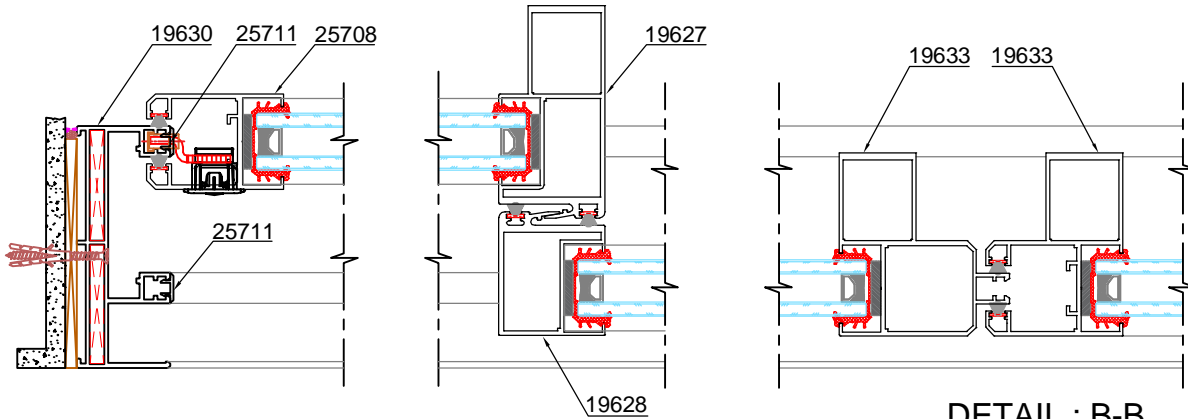

DETAIL : B-B

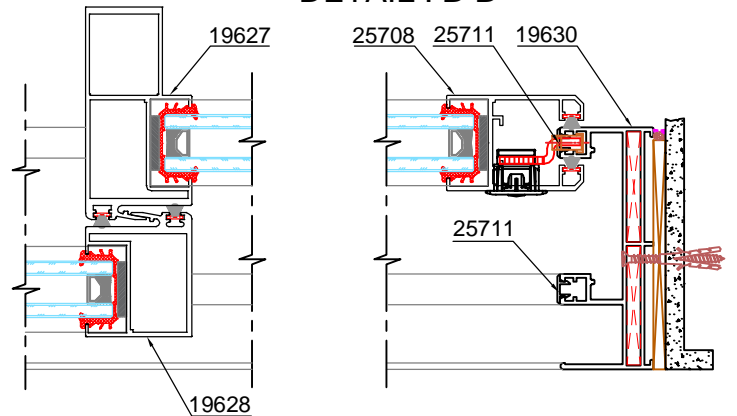

ASSEMBLY DRAWING

3-TRACK DOOR / 6-SASH

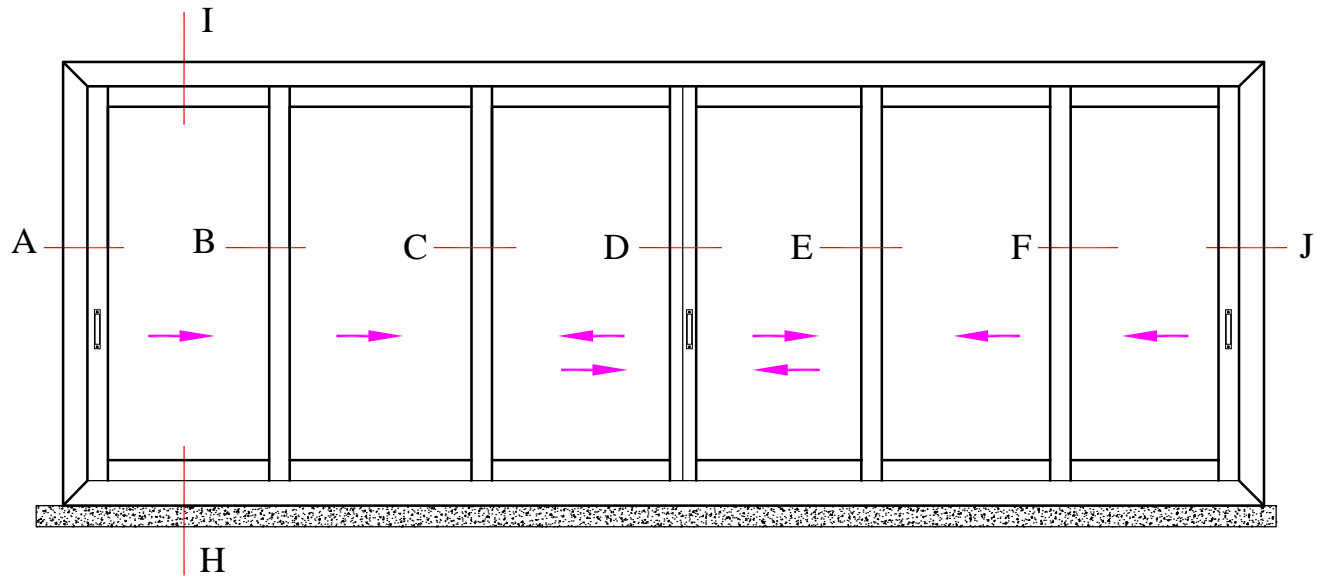

All dimension in cross sections are shown in mm
Profiles are not necessarily shown to scale

ASSEMBLY DRAWING

DETAIL - A

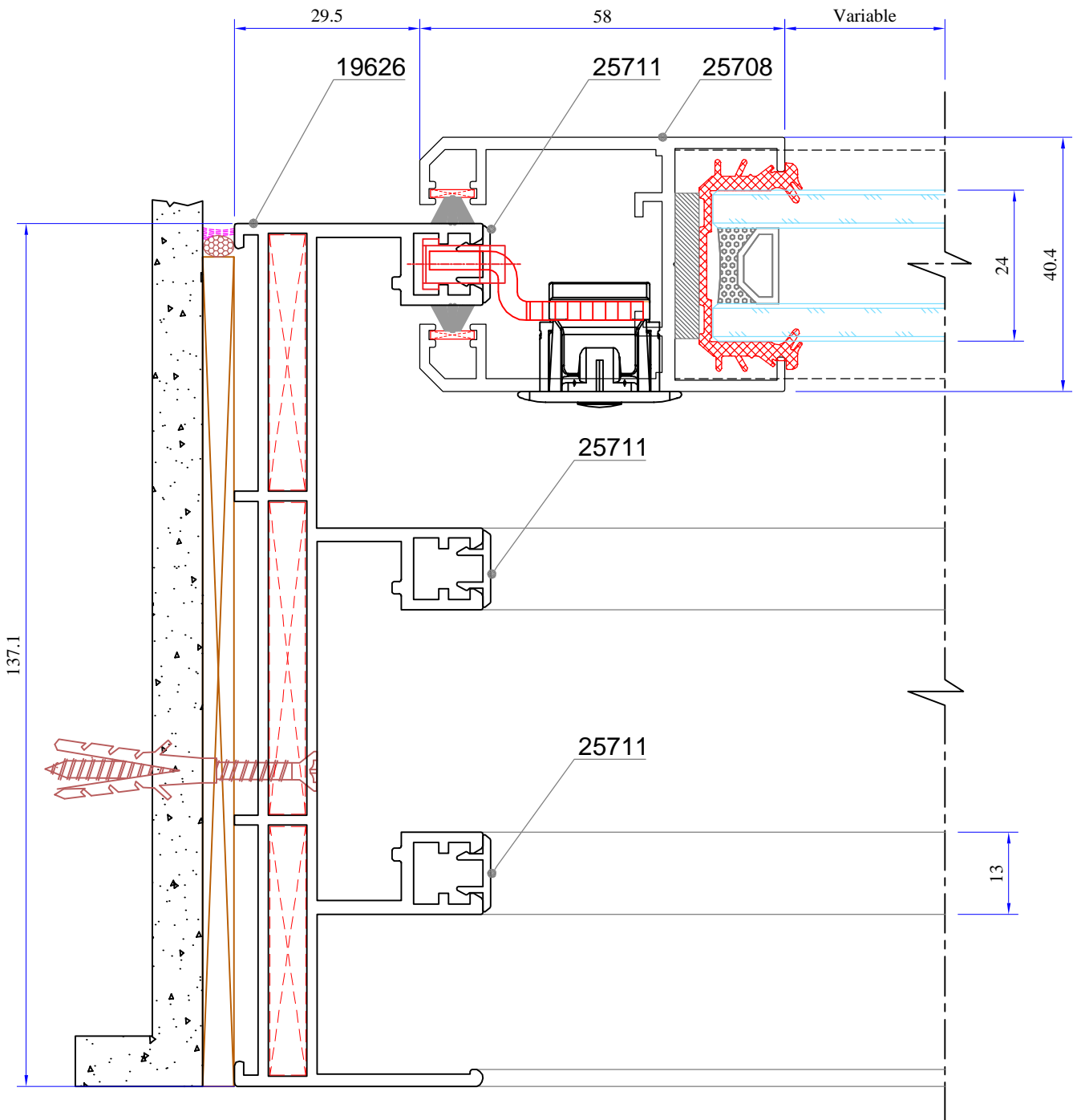

ASSEMBLY DRAWING

DETAIL - B

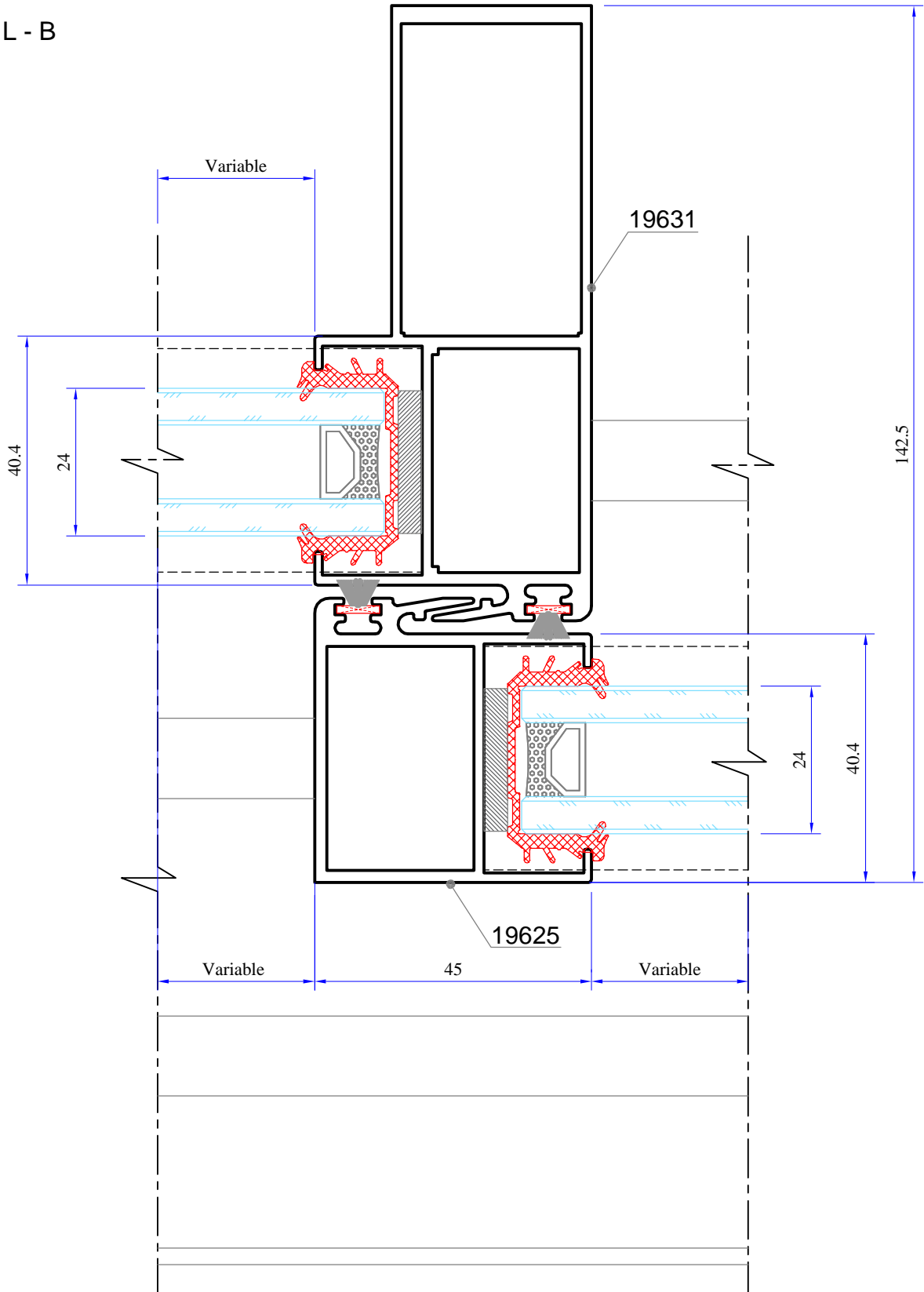

ASSEMBLY DRAWING

DETAIL - C

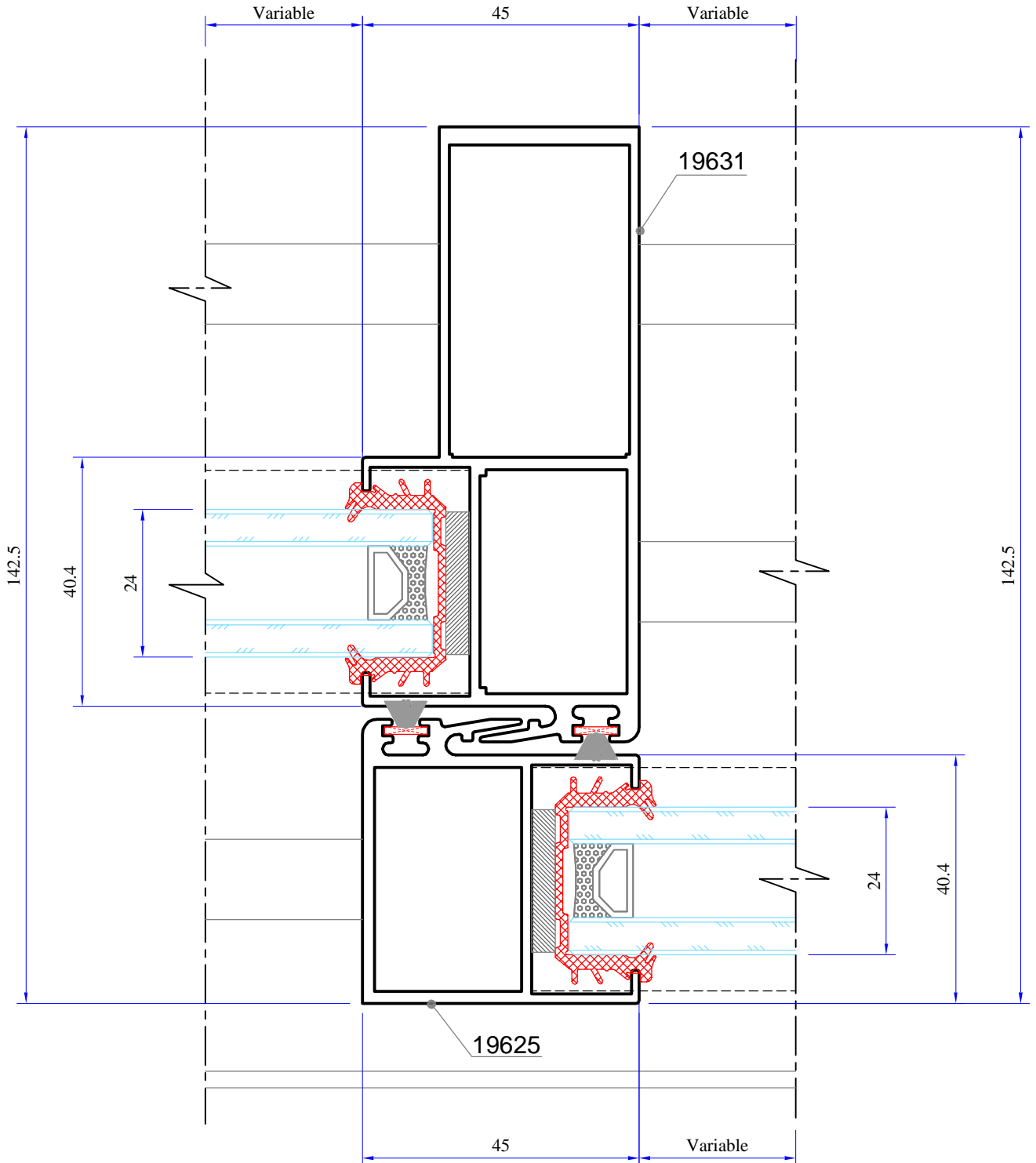

ASSEMBLY DRAWING

DETAIL - D

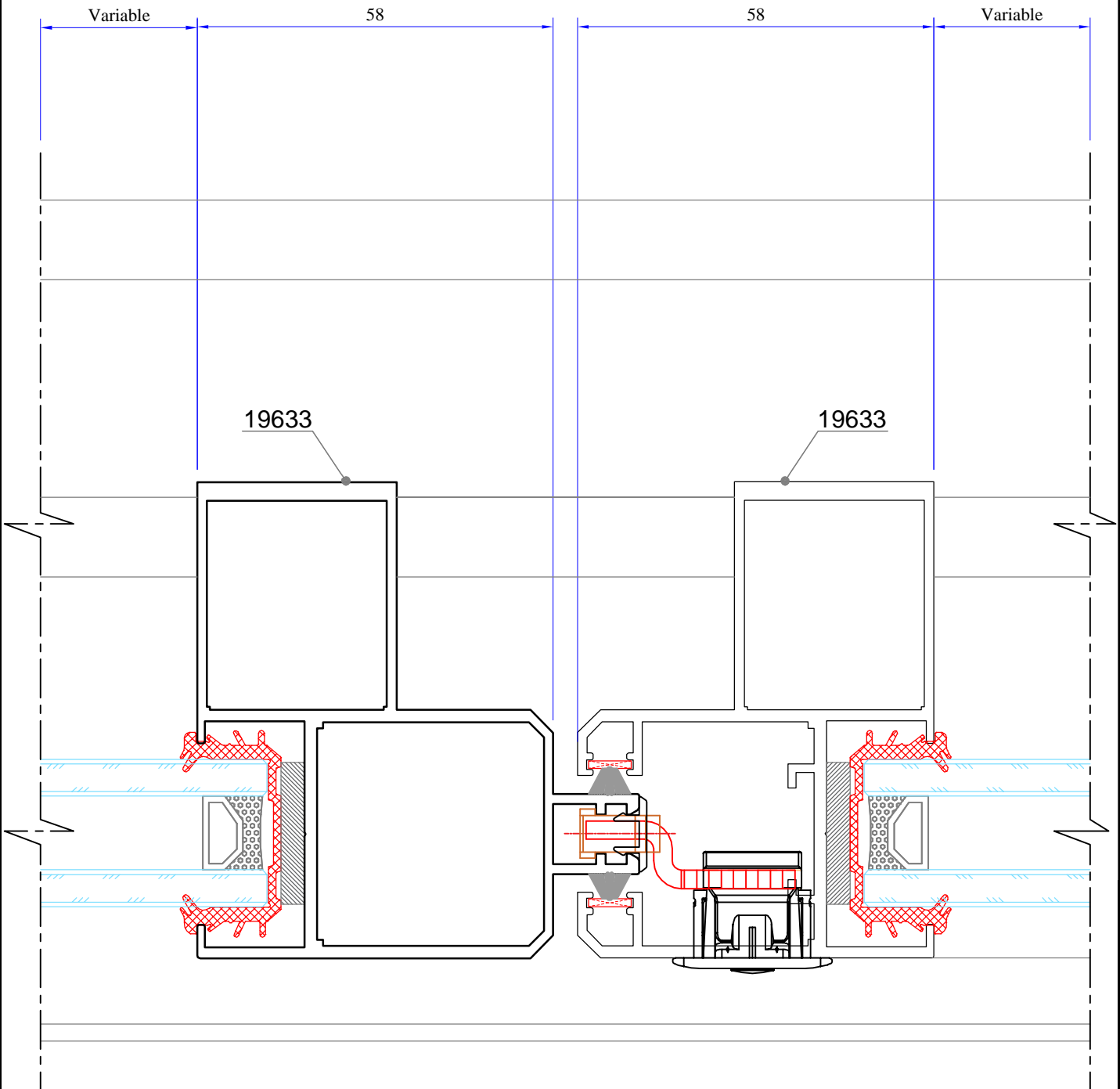

ASSEMBLY DRAWING

DETAIL - E

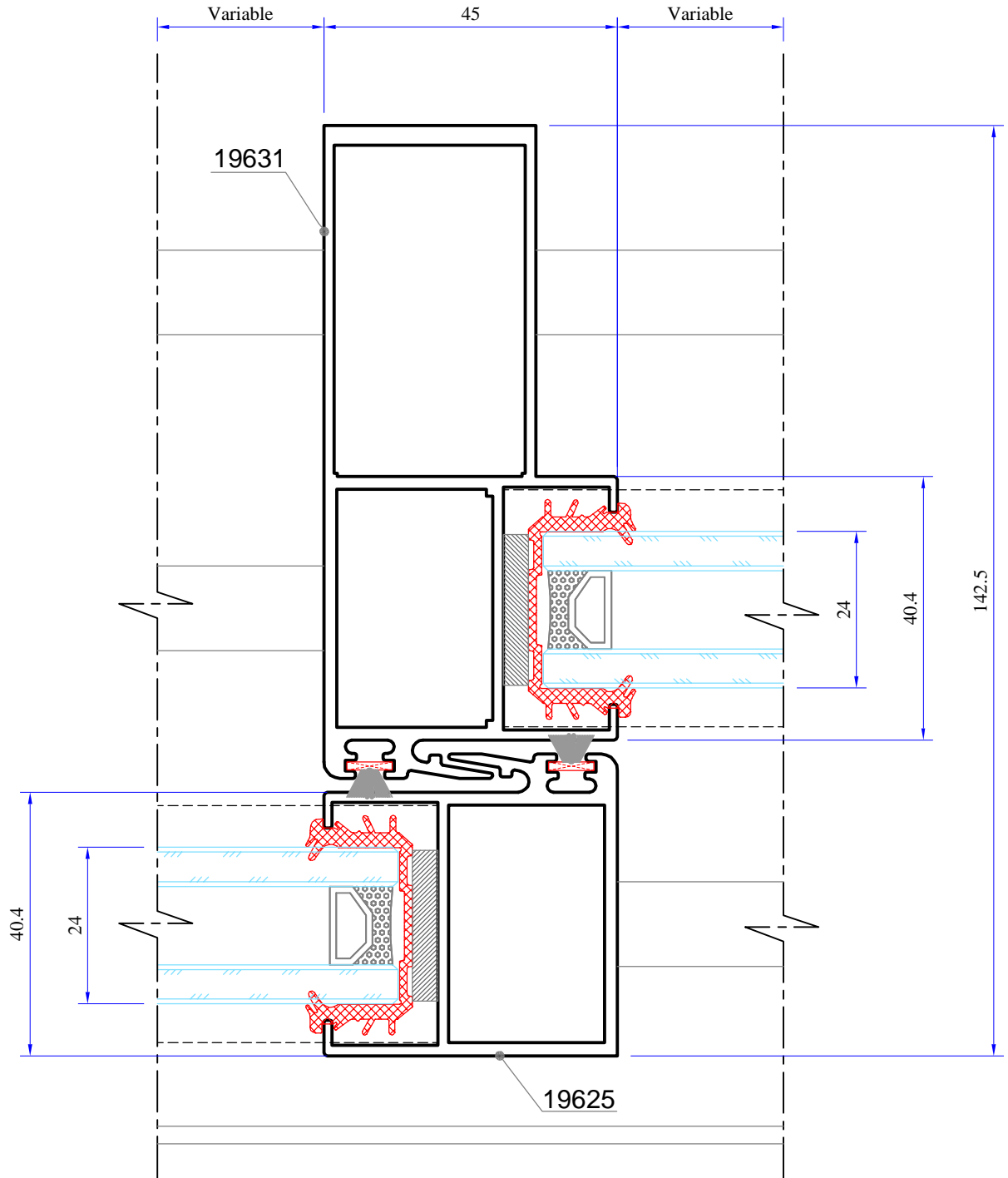

ASSEMBLY DRAWING

DETAIL - F

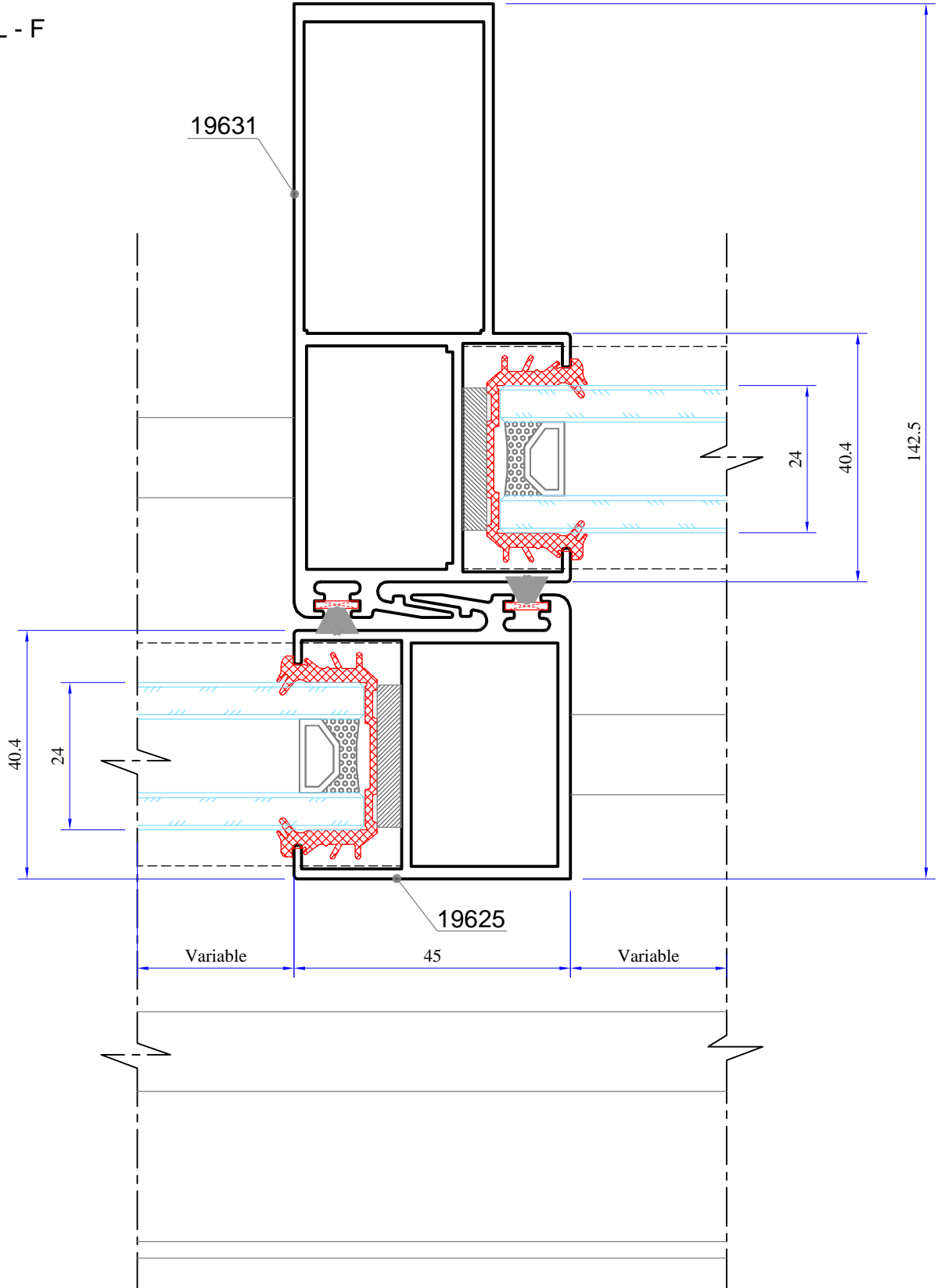

ASSEMBLY DRAWING

DETAIL - J

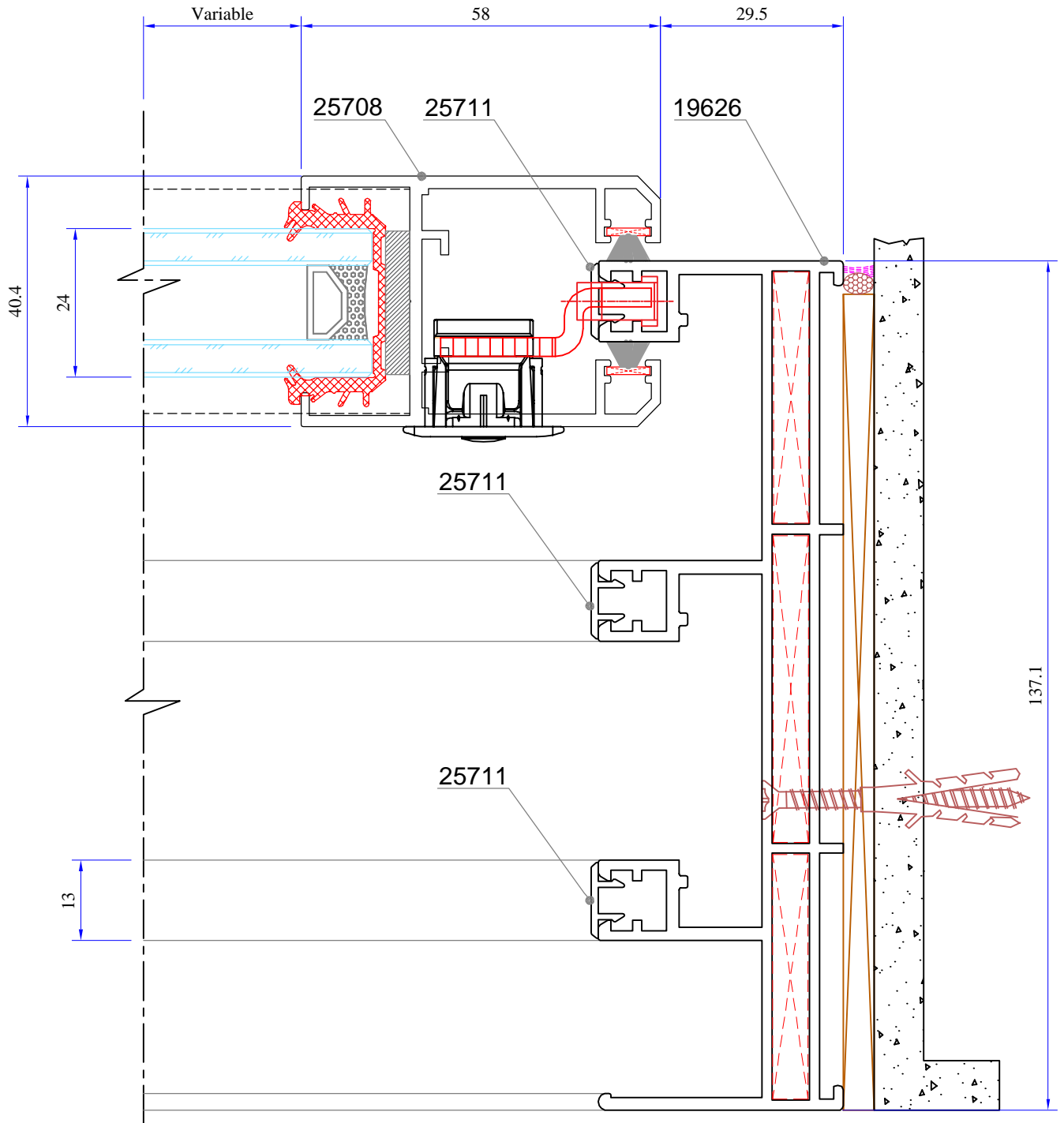

ASSEMBLY DRAWING

DETAIL - H

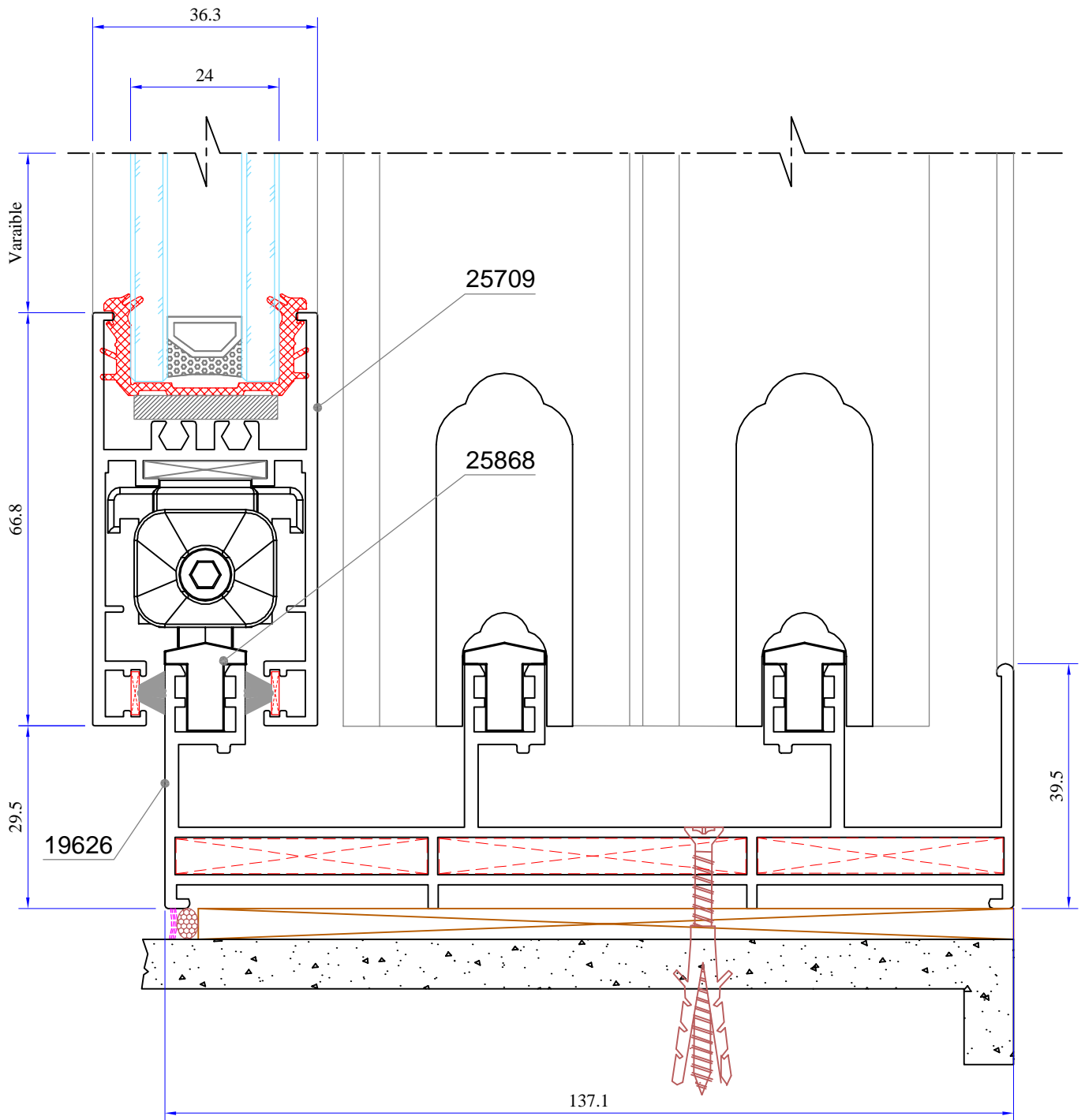

ASSEMBLY DRAWING

DETAIL - I

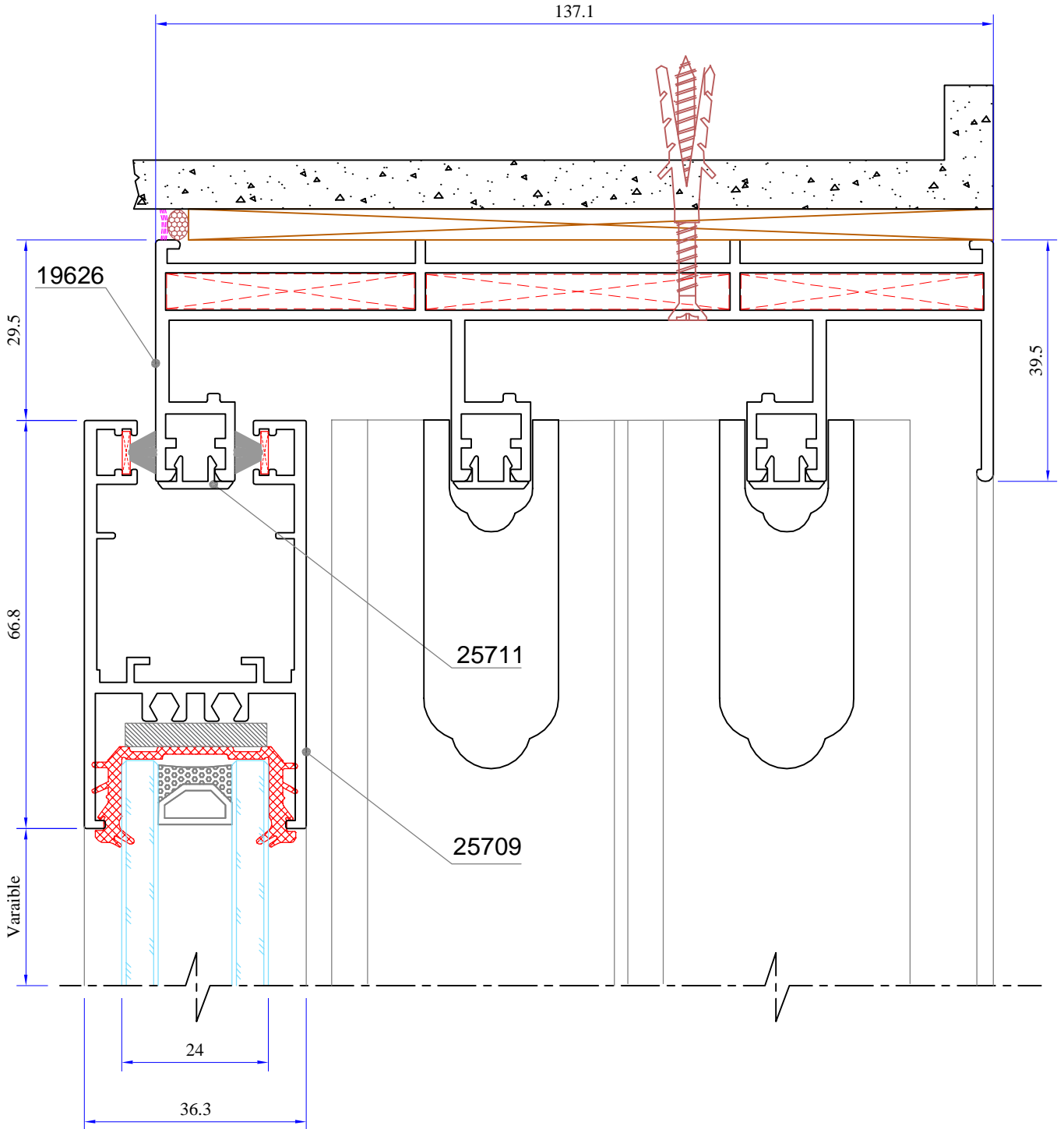

ASSEMBLY DRAWING

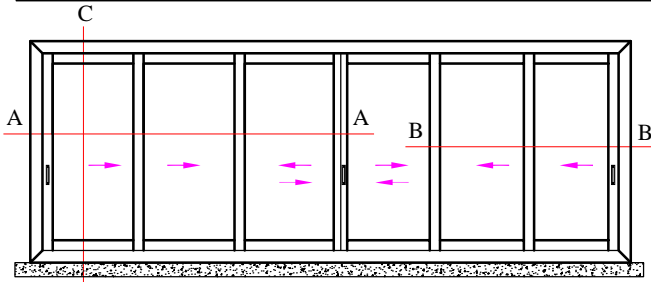

6 - SASH WINDOW / DOOR

PROFILES (Single Glazed)		
Description	Shape	Section No.
Frame		19626
Bottom/Top Sash		25709
Side Sash		25708
Interlock		19625
Interlock		19631
Meeting section		19633
Cap Side & top		25711
Bottom Secion		25868

